

**PRODUCT TECHNICAL SHEET**

Collection : **PILE & FACE**

Ref. : **1002.--.97**

Robinet double service équerre

Dubbele dienstkraan recht model

Double service tap, square model

**Picture**

**Product details**

Weight : 0,6 kg



Internal mechanism : 1/3 turn compression valve

**Technical drawing**

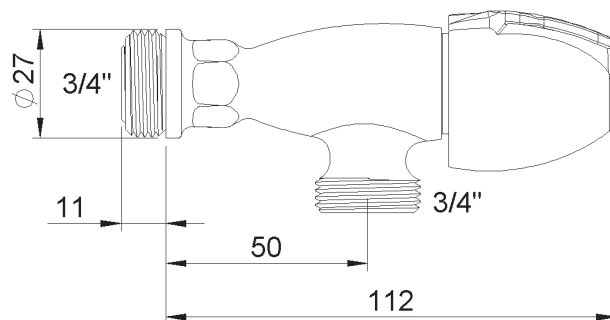

RAO.V01